

MK
MOOV

Stile, design, innovazione,
qualità del prodotto,
rispetto per l'ambiente
e per le persone.

*Style, design, innovation,
quality of the product,
respect for the environment
and for people.*

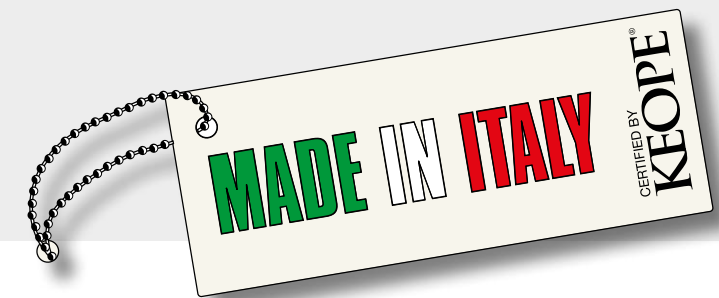

Made in Italy

Ceramiche Keope



In Ceramiche Keope riteniamo che la **responsabilità sociale** di un'impresa si manifesti innanzitutto operando con **trasparenza e correttezza** nei confronti di tutti gli interlocutori, siano essi clienti, fornitori, collaboratori.

Per questo motivo abbiamo aderito con convinzione al "codice etico" di Confindustria Ceramica che impegna a **comunicare con chiarezza l'origine dei nostri prodotti**.

Riteniamo che il marchio "Made in Italy" sia garanzia di valori forti quali **stile, design, innovazione e qualità del prodotto**, ma soprattutto rappresenti **rispetto per l'ambiente e per le persone**.

Siamo convinti che le nostre ceramiche "Made in Italy" siano sinonimo di qualità, design, ed etica del lavoro e pertanto, con orgoglio, comunichiamo e promuoviamo questo valore.

At Ceramiche Keope, we believe that the **social responsibility** of a company should express itself by means of a **transparent and correct approach** to all interlocutors, irrespective of whether they are customers, suppliers or co-operators.

For this reason, we have chosen to comply with the "code of ethics" of Confindustria Ceramica (Italian association of ceramic industries), which means that we **must clearly indicate the origin of our products**.

We believe that the "Made in Italy" mark guarantees strong values, such as for instance **style, design, innovation and quality of the product**, and above all respect, **for the environment and for people**. We are convinced that "Made in Italy" means products of top quality, with a high standard of design and manufactured in accordance to work ethics. Therefore, we are proud to inform you of the above and to promote these values.

*Architectural
concrete design*



Moov Grey
p. 6



Moov Anthracite
p. 14



Moov Beige
p. 20



Moov Moka
p. 26



Moov Ivory
p. 32



GRES PORCELLANATO . PORCELAIN STONEWARE

MOOV

*Gusto contemporaneo per atmosfere suggestive.
Moov incarna l'eleganza dell'urban style grazie a una grafica
morbida, caratterizzata da un leggero movimento che trae
ispirazione dai materiali cementizi, esaltandone la materia.*

*A completare la gamma Keope propone le grandi lastre 120x240
per arricchire di nuove opportunità progettuali
l'architettura contemporanea, ed offrire tutto il valore tecnico
ed estetico del gres porcellanato.*

*Contemporary taste for evocative atmospheres.
Moov embodies the elegance of an urban style thanks to its soft graphics,
characterized by a slight movement that is inspired by cement-based
materials, thus enhancing the matter.*

*To complete the range, Keope offers the maxi plates 120x240
which enrich contemporary architecture with
new design opportunities and offer all the technical
and aesthetic values of fine porcelain stoneware.*

CERAMICHE
KEOPE[®]

La palette cromatica gioca su nuances contemporanee, spaziando da tinte chiare e delicate fino a toni più intensi e distintivi. L'ampia gamma di formati e le tre finiture superficiali fanno di Moov una collezione completa che consente la massima libertà progettuale, pensata per interni ed esterni capaci di stupire e lasciare spazio all'immaginazione.

The color palette plays with contemporary nuances, ranging from light and delicate shades to more intense and distinctive tones. Moov's wide range of sizes and three surface finishes create a complete collection that allows maximum freedom of design, intended for both indoor and outdoor work, capable of surprising and allowing room for imagination.

MOOV

I N D O O R

120x240 . 120x120* . 60x120 . 30x120 . 20x120
60x60 . 30x60 . 14,7x60 . 9,7x60
6,4x60 . 3,1x60 . 45x45 . 7,5x30*



O U T D O O R

30x60 Grip

*90x90 . 60x60 Strutturato spessore 20 mm - K2
Textured 20 mm thickness - K2*

Gres porcellanato
*1 Porcelain stoneware . Grès cérame
Feinsteinzeug . Gres porcelanico*

5 colori
colours
14 formati
sizes

3 surfaces
3 superfici
2 spessori
1 thicknesses

Moov Grey

*Espressione del vivere moderno.
Expression of modern living.*

Moov Grey è materia d'ispirazione per spazi ricercati, dal taglio architettonico contemporaneo e dall'atmosfera rilassante.

Moov Grey is material made to inspire sought after spaces, with a contemporary architectural cut and a relaxing atmosphere.









Moov Anthracite

*Avvolgenti sensazioni di esclusività.
Enchanting feeling of exclusivity.*

Elegante e funzionale, Moov Anthracite è capace di trasformare spazi residenziali e pubblici in ambienti raffinati e accoglienti.

Elegant and functional, Moov Anthracite is capable of transforming public and residential spaces into refined and welcoming environments.

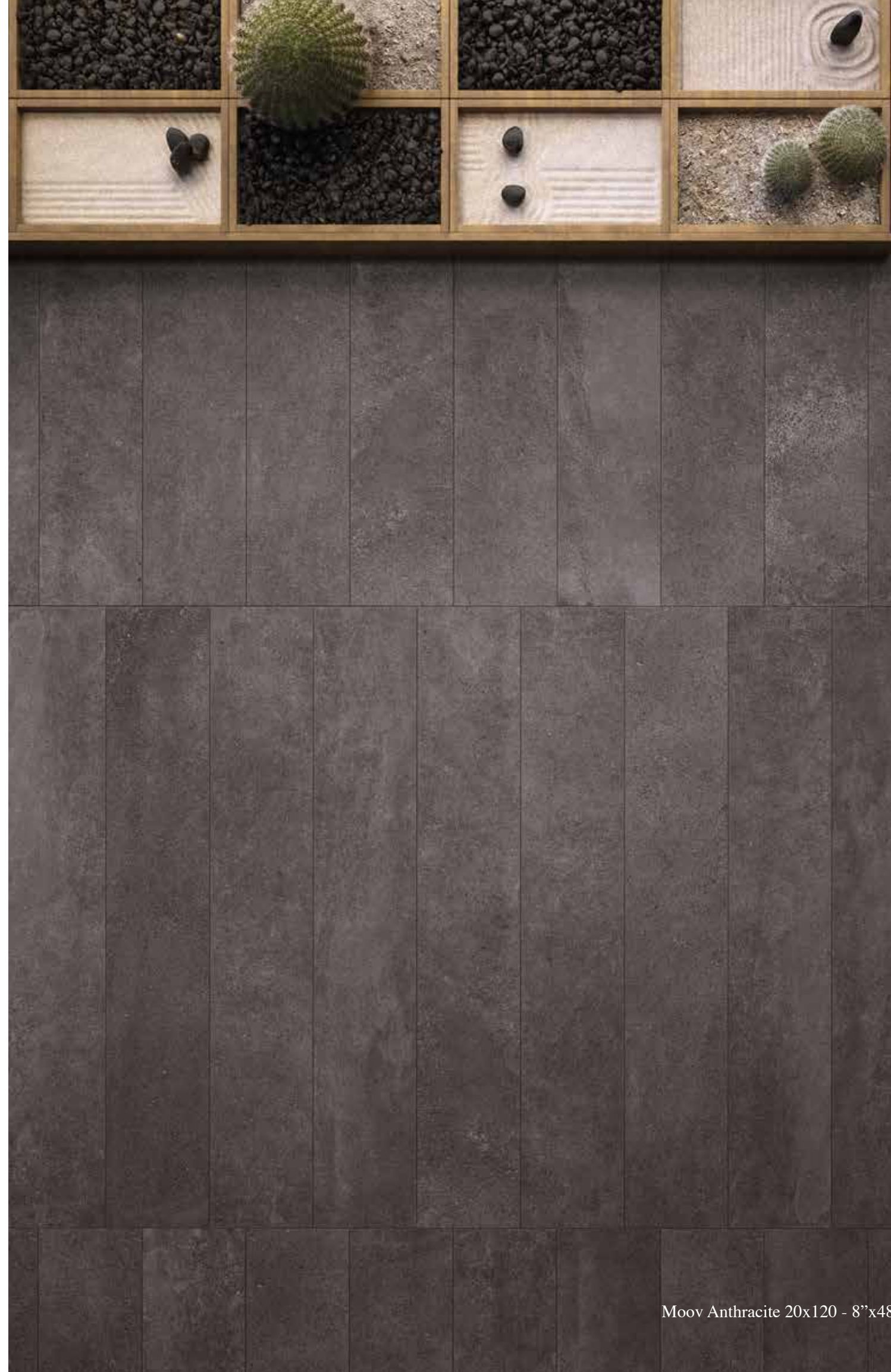





Moov Anthracite 20x120 - 8"x48" Nat Rt

Moov Beige

*Momenti di intima eleganza.
Moments of intimate elegance.*

Con Moov Beige è possibile disegnare ambienti che abbiano intimità e calore senza rinunciare alla freschezza dello stile contemporaneo.

Moov Beige allows you to design an ambient with intimacy and warmth without sacrificing the freshness of a contemporary style.







Moov Moka

*Dettagli d'autore.
Innovative touches.*

Moov Moka si inserisce con eleganza in contesti sofisticati,
per reinterpretare in un'ottica nuova
gli spazi architettonici.

Moov Moka presents itself with elegance in sophisticated contexts,
so as to reinterpret architectural
spaces in a new perspective.





Rendez-vous
hotel • restaurant • lounge

Moov Moka 60x120 - 24"x48" Nat Rt



Moov Ivory

*Giochi di design.
Design games.*

Moov Ivory esalta il look essenziale degli ambienti, sfruttando accostamenti di forme e colori originali per sposare il design più attuale.

Moov Ivory enhances the essential look of environments by using combinations of forms and original colors so as to embrace the most current design.





Moov Ivory 60x60 - 24"x48" Nat Rt
Moov Ivory 30x60 - 12"x48" Nat Rt



Moov Ivory 60x60 - 24"x48" Nat Rt
Moov Ivory 30x60 - 12"x48" Nat Rt





Moov Ivory 120x240 - 48"x96" Nat Ret
Moov Ivory 120x120 - 48"x48" Nat Ret
Moov Ivory Mosaico 30x30 - 12"x12"

Idro Moov



Moov Grey Comp. Idro Moov Leaf
240x240 - 96"x96"

Idro Moov

Leaf - City - Brick

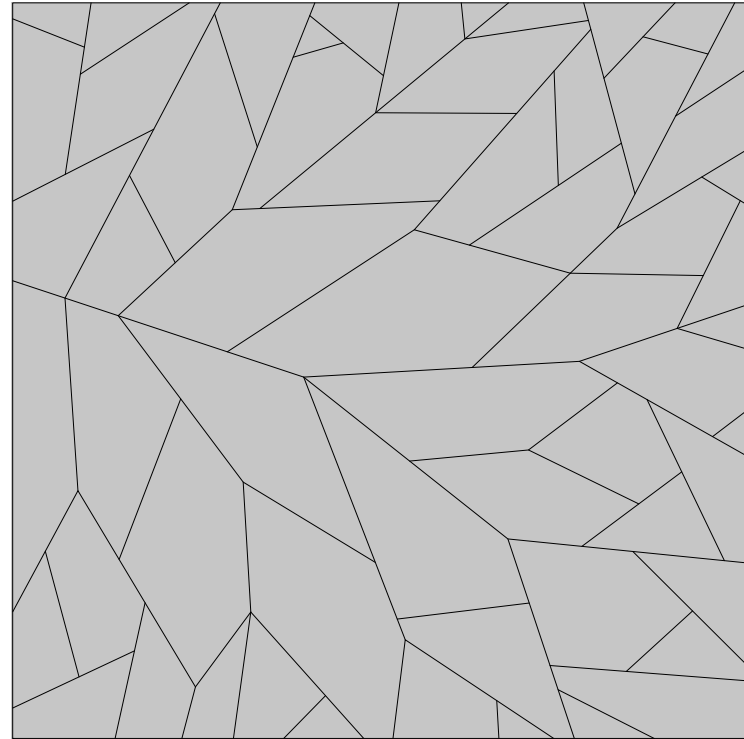

I decori IDRO MOOV LEAF, CITY e BRICK sono personalizzabili in dimensione e possono essere realizzati anche con più combinazioni di colore.

The decorations IDRO MOOV LEAF, city and BRICK are customizable in size and can be realized with different colors combinations

▲ COMP. IDRO MOOV LEAF
240x240 - 96"x96"

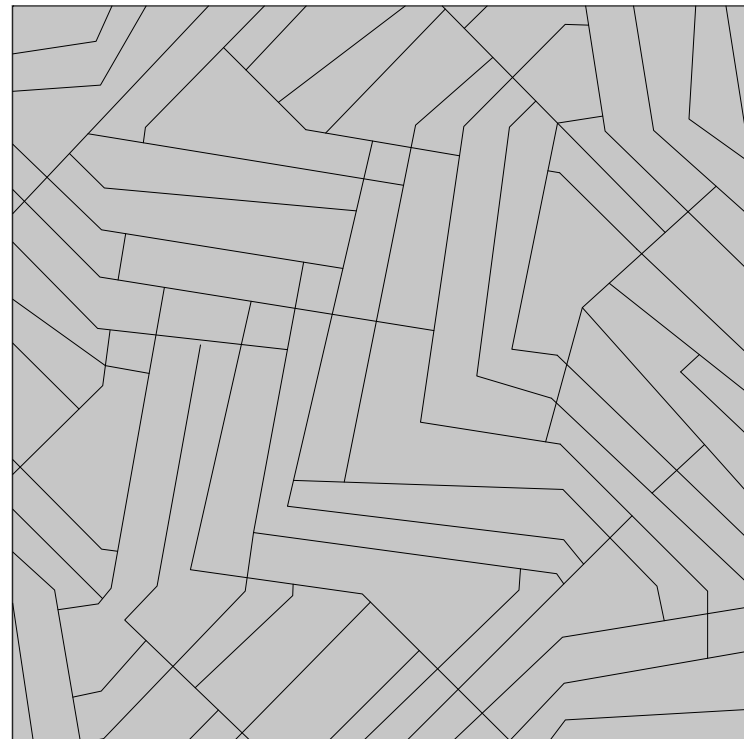

▲ COMP. IDRO MOOV CITY
240x240 - 96"x96"

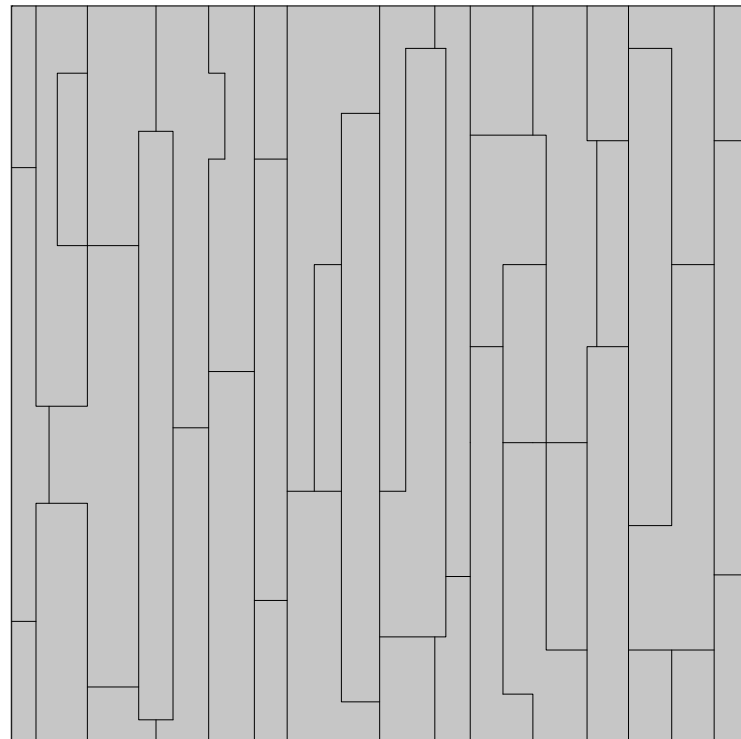

▲ COMP. IDRO MOOV BRICK
240x240 - 96"x96"



7,5x30
3"x12"
NAT.

BRIK

GRES PORCELLANATO . PORCELAIN STONEWARE
GRÈS CÉRAMÉ . FEINSTEINZEUG . GRES PORCELANICO

NATURALE . NATURAL .
NATUREL . NATURBELASSEN . NATURAL

Brik Moov Ivory



Brik Moov Moka





Brik Moov Ivory 7,5x30 - 3"x12" Nat
in abbinamento a / combined to:
Moov Anthracite 60x60 - 24"x24" Nat Rt
Moov Anthracite 30x60 - 12"x24" Nat Rt



Brik Moov Moka 7,5x30 - 3"x12" Nat

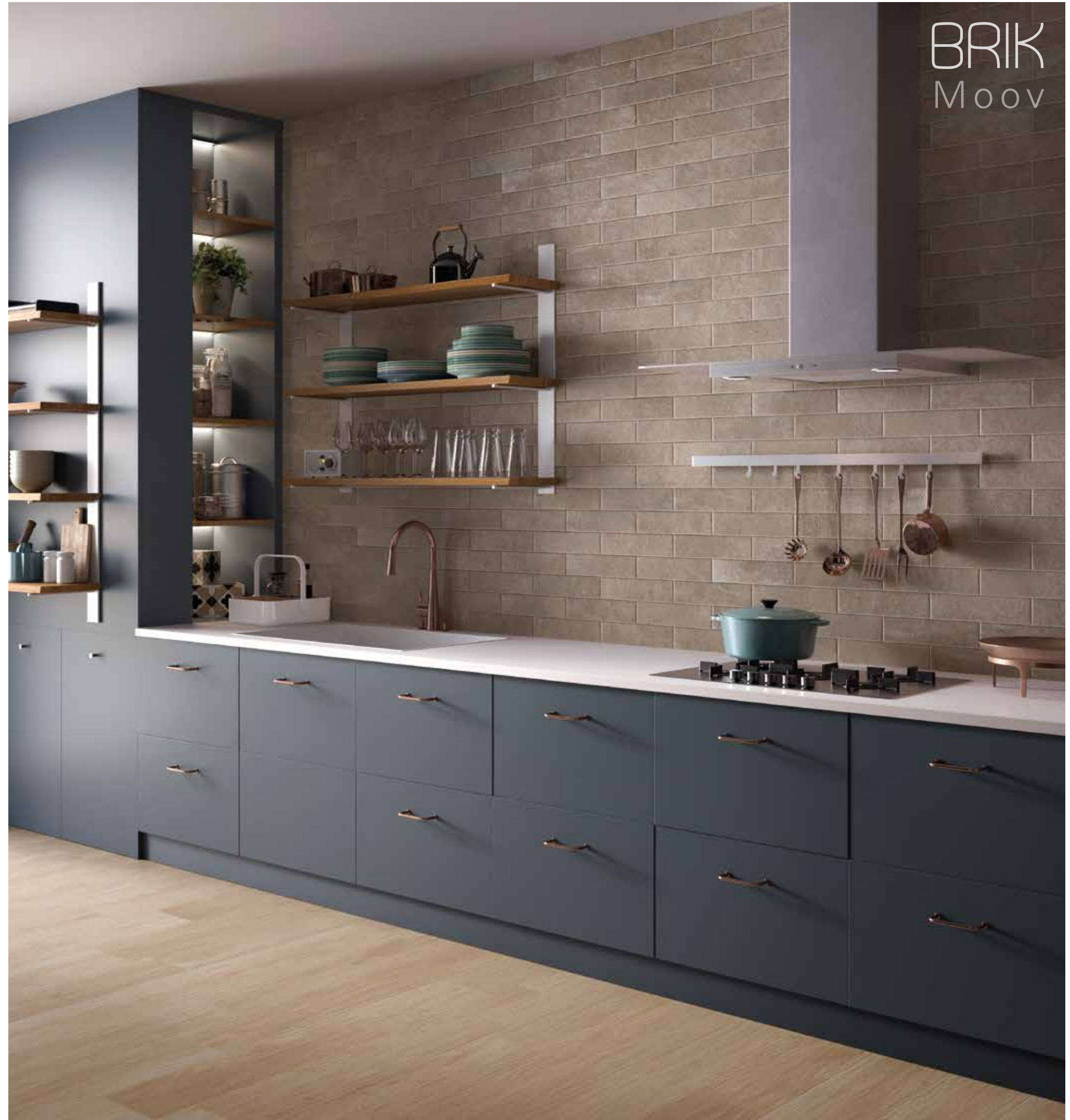

Brik Moov Moka 7,5x30 - 3"x12" Nat
in abbinamento a / combined to:
Note Honey 20x120 - 8"x48" Nat Rt

Il sistema intelligente in GRES PORCELLANATO a spessore 2 CM per pavimentazioni in SPAZI ESTERNI.



Completa VERSATILITÀ di POSA per tutte le esigenze di applicazione. K2 arreda facilmente gli spazi all'aperto.

Complete LAYING VERSATILITY for all application requirements. K2 is a design feature for outdoor spaces.

VERSATILITE complète de la POSE pour toutes les exigences d'application. K2 décore aisément les espaces à ciel ouvert.

Vollständige VIELFÄLTIGKEIT der VERLEGUNG für alle Anwendungserfordernisse. K2 gestaltet mühelos Bereiche unter freiem Himmel.



POSA A SECCO IN APPOGGIO SU:

Dry laying on:
Pose à sec en appui sur:
Trockene verlegung Durch Auflage auf:

| | | |
|---|--|--|
| ERBA Grassy ground Sols herbeux Rasen | GHIAIA Gravel Gravier Kies | SABBIA Sand Sable Sand |
|---|--|--|

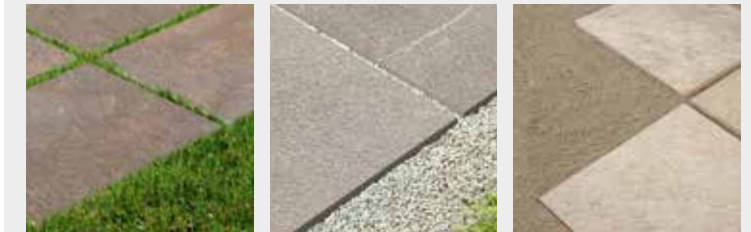

POSA SU MASSETTO CON COLLA

Laying on screed with adhesive
Pose sur chape avec de la colle
Verlegung auf Estrich mit Kleber



POSA SOPRAELEVATA CON SUPPORTO:

Raised laying with support:
Pose surelevée avec support:
Verlegung auf Hohlraumboden mit Halterung:



The intelligent paving system 2 CM-thickness PORCELAIN STONEWARE TILES for OUTDOOR APPLICATIONS.

Le système intelligent en GRÈS CÉRAME de 2 CM d'épaisseur destiné au pavage des ESPACES EXTÉRIEURS.

Das intelligente System aus FEINSTEINZEUG mit 2 CM Stärke für BODENBELÄGE IM AUSSENBEREICH.



PER LA CASA

FOR THE HOME . POUR LA MAISON . FÜR DIE WOHNUNG

| | | | |
|---|--|---|---|
| camminamenti vialetti sentieri su prato o ghiaia verande piscine aree cortilive garage scale | walkways driveways paths on grass or gravel verandas swimming pools courtyards garages stairs | passage allées sentiers sur pelouse ou gravier vérandas piscines cours garages escaliers | Laufwege Wege Pfade auf Rasen oder Kies Veranden Schwimmbäder Hofbereiche Garage Treppen |
|---|--|---|---|



NEGLI SPAZI PUBBLICI

FOR PUBLIC SPACES . DANS LES ESPACES PUBLICS . IN ÖFFENTLICHEN BEREICHEN

| | | | |
|--|---|---|---|
| servizi pubblici alberghi stabilimenti balneari negozi ristoranti bar centri benessere arredo urbano passaggi in sicurezza | public services hotels private beaches shops restaurants bars wellness centres urban design safety passages | services publics hôtels établissements balnéaires magasins restaurants bars centres de bien-être mobiliers urbains passages sécurisés | Öffentliche Dienstleistungen Hotels Badeeinrichtungen Geschäfte Gaststätten Bar Wellness-Center Stadteinrichtung Schutzwege |
|--|---|---|---|

K2 introduce una nuova prospettiva progettuale. **K2** mette a disposizione degli architetti e professionisti uno strumento nuovo per creare continuità di superficie tra interni ed esterni. Infatti, è studiata per trovare continuità di superficie nelle collezioni di Keope per interni anche a spessore 1 cm nella versione R9.

K2 introduces a new design perspective. **K2** offers architects and professionals a new instrument to create continuity between interior and exterior surfaces. Indeed, it is designed to create continuity even between the surfaces of the Keope 1 cm thick interior and exterior collections in the R9 version.

K2 introduit une nouvelle perspective conceptuelle. **K2** met à la disposition des architectes et des professionnels un nouvel instrument pour créer une continuité de surface entre l'intérieur et l'extérieur. En effet, il est conçu pour trouver une continuité de surface dans les collections de Keope pour l'intérieur également d'une épaisseur de 1 cm dans la version R9.

K2 führt eine neue Entwurfsperspektive ein. **K2** stellt den Architekten und Fachleuten ein neues Hilfsmittel zur Verfügung, um durchgängige Oberflächen zwischen Innen- und Außenbereichen zu schaffen. Tatsächlich wurde entwickelt, um unterbrechungslose Oberflächen mit den Kollektionen von Keope für Innenbereiche auch mit einer Dicke von 1 cm in der Ausführung R9 zu schaffen.

STRUTTURATO RETTIFICATO
TEXTURED RECTIFIED · STRUCTURÉ RECTIFIÉ · STRUKTURIERT REKTIFIZIERT · ESTRUCTURADO RECTIFICADO

FORMATI

SIZES · FORMATS
FORMATE · FORMATOS

SPESORE 20 mm

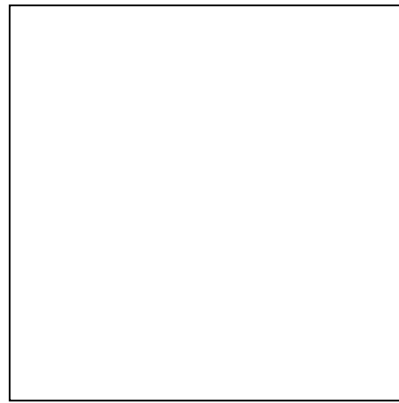

90x90
36"x36"
STRUTT. RT

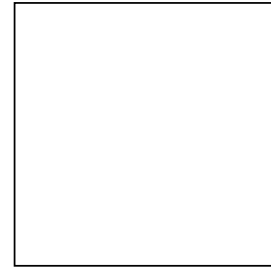

60x60
24"x24"
STRUTT. RT

COLORI

COLOURS · COULEURS
FARBEN · COLORES



MOOV GREY



MOOV BEIGE



MOOV MOKA



MOOV ANTHRACITE

PEZZI SPECIALI

TRIMS · PIÈCES SPÉCIALES
FORMTEILE · PIEZAS ESPECIALES

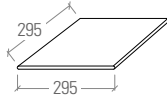

Angolare bordo con toro
30x30

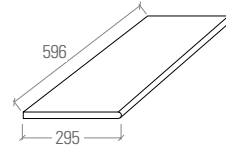

Bordo con toro
30x60

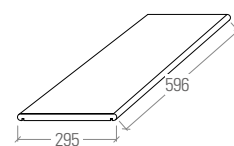

Top
30x60

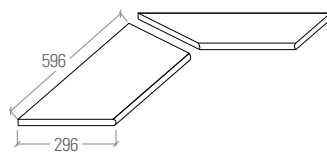

Angolo interno
bordo con toro
30x60

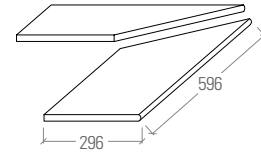

Angolo esterno
bordo con toro
30x60

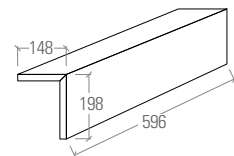

Cordolo "L"
60x20x15

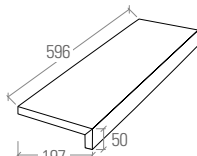

Terminale "L"
60x20x5

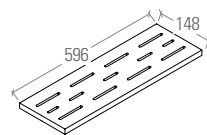

Griglia
15x60

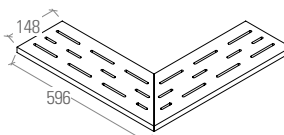

Angolo griglia
15x60

Le quote indicate nei disegni sono espresse in mm. The values in the drawings are expressed in mm.
Les cotes indiquées sur les dessins sont exprimées en mm. Die in den Zeichnungen angegebenen Höhen sind in mm ausgedrückt.



Per dettagli sul prodotto in 20 mm di spessore e sui relativi sistemi di posa ed, in particolare, per le raccomandazioni, accorgimenti, limitazioni di utilizzo e precauzioni in fase di posa, si raccomanda di prendere visione del catalogo K2 e del sito www.keope.com

For further details on the 20 mm product and the installation systems, in particular for recommendations, restrictions of use, and precautions during installation, please refer to www.keope.com website and to the 20 mm catalogue K2.

Pour de plus amples détails sur les produits de 20 mm d'épaisseur et sur leurs systèmes de pose, et en particulier, pour les recommandations, mises à jour, limitations d'usage et précautions en phase de pose, veuillez prendre connaissance du catalogue K2 et du site www.keope.com

Für details zum produkt mit 20 mm stärke und entsprechende verlegesysteme, insbesondere hinsichtlich hinweise und anmerkungen, nutzungseinschränkungen und vorsichtsmassnahmen während der verlegung, wird die einsicht des katalogs K2 und der webseite www.keope.com empfohlen.

Para más detalles sobre el producto de 20 mm de espesor y el sistema de colocación correspondiente, así como consejos, precauciones, límites de uso y medidas a tomar durante la colocación, consulte el catálogo K2 y el sitio web www.keope.com

Grey

NATURALE . NATURAL . NATUREL . NATURBELASSEN . NATURAL
 NATURALE RETTIFICATO . NATURAL RECTIFIED . NATUREL RECTIFIÉ . NATURBELASSEN REKTIFIZIERT . NATURAL RECTIFICADO
 GRIP RETTIFICATO . GRIP RECTIFIED . GRIP RECTIFIÉ . GRIP REKTIFIZIERT . GRIP RECTIFICADO

MOOV

FORMATI . SIZES . FORMATS . FORMATS . FORMATS . FORMATS

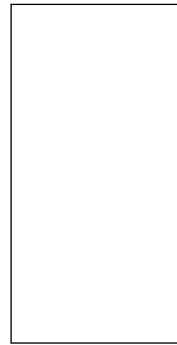
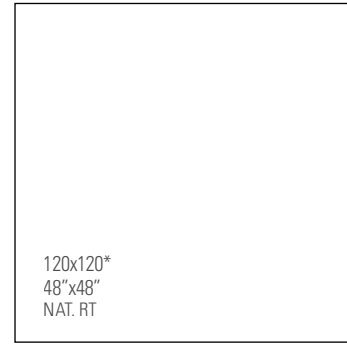
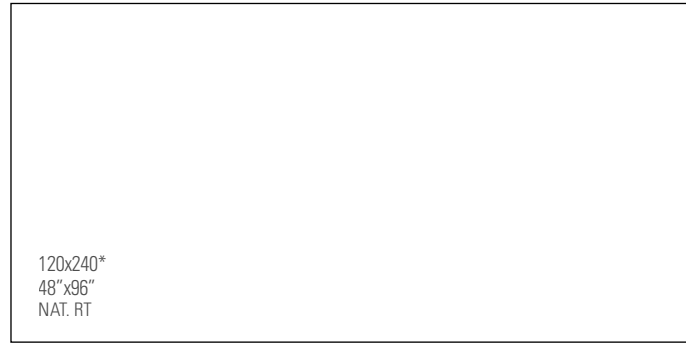

60x120
24"x48"
NAT. RT



30x120
12"x48"
NAT. RT



20x120
8"x48"
NAT. RT

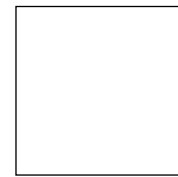

60x60
24"x24"
NAT. RT

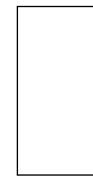

30x60
12"x24"
NAT. RT
GRIP RT



14,7x60
5 3/4"x24"
NAT. RT

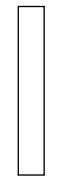

9,7x60
3 7/8"x24"
NAT. RT

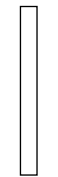

6,4x60
2 1/2"x24"
NAT. RT



3,1x60
1 1/4"x24"
NAT. RT

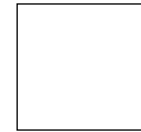

45x45
18"x18"
NAT.



*Misura Nominale - Nominal Size: 1195x2390 mm - 1195x1195 mm

Anthracite

NATURALE . NATURAL . NATUREL . NATURBELASSEN . NATURAL
 NATURALE RETTIFICATO . NATURAL RECTIFIED . NATUREL RECTIFIÉ . NATURBELASSEN REKTIFIZIERT . NATURAL RECTIFICADO
 GRIP RETTIFICATO . GRIP RECTIFIED . GRIP RECTIFIÉ . GRIP REKTIFIZIERT . GRIP RECTIFICADO

MOOV

FORMATI . SIZES . FORMATS . FORMATS . FORMATS . FORMATS

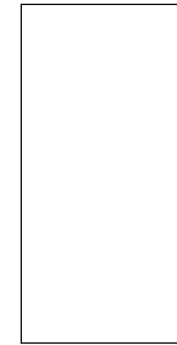
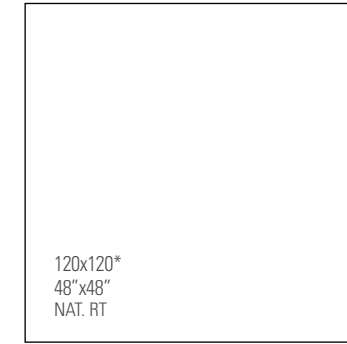
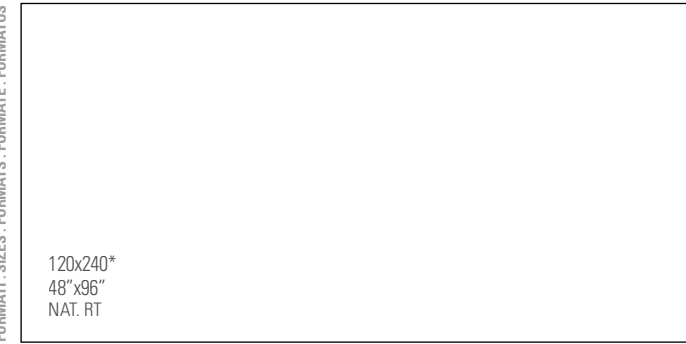

60x120
24"x48"
NAT. RT

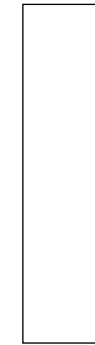

30x120
12"x48"
NAT. RT



20x120
8"x48"
NAT. RT

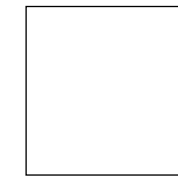

60x60
24"x24"
NAT. RT

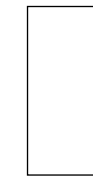

30x60
12"x24"
NAT. RT
GRIP RT



14,7x60
5 3/4"x24"
NAT. RT



9,7x60
3 7/8"x24"
NAT. RT



6,4x60
2 1/2"x24"
NAT. RT



3,1x60
1 1/4"x24"
NAT. RT

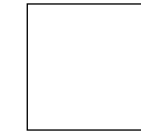

45x45
18"x18"
NAT.



*Misura Nominale - Nominal Size: 1195x2390 mm - 1195x1195 mm



Beige

NATURALE . NATURAL . NATUREL . NATURBELASSEN . NATURAL
 NATURALE RETTIFICATO . NATURAL RECTIFIED . NATUREL RECTIFIÉ . NATURBELASSEN REKTIFIZIERT . NATURAL RECTIFICADO
 GRIP RETTIFICATO . GRIP RECTIFIED . GRIP RECTIFIÉ . GRIP REKTIFIZIERT . GRIP RECTIFICADO

MOOV
 FORMATTI . SIZES . FORMATS . FORMATS . FORMATS . FORMATS

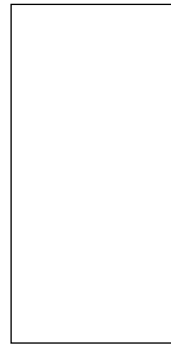
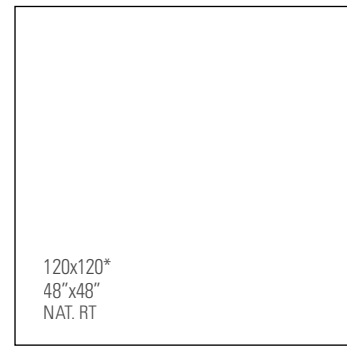
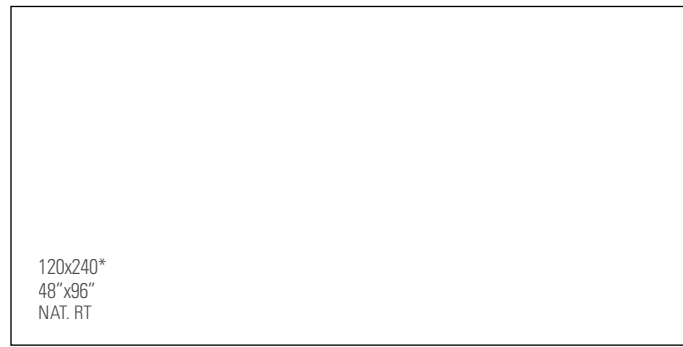

60x120
 24"x48"
 NAT. RT



30x120
 12"x48"
 NAT. RT



20x120
 8"x48"
 NAT. RT

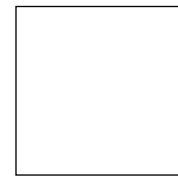

60x60
 24"x24"
 NAT. RT

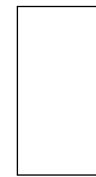

30x60
 12"x24"
 NAT. RT
 GRIP RT



14,7x60
 5 3/4"x24"
 NAT. RT

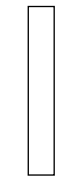

9,7x60
 3 7/8"x24"
 NAT. RT



6,4x60
 2 1/2"x24"
 NAT. RT

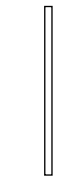

3,1x60
 1 1/4"x24"
 NAT. RT

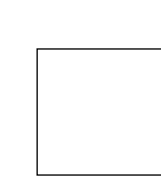

45x45
 18"x18"
 NAT.



*Misura Nominale - Nominal Size: 1195x2390 mm - 1195x1195 mm

Moka

NATURALE . NATURAL . NATUREL . NATURBELASSEN . NATURAL
 NATURALE RETTIFICATO . NATURAL RECTIFIED . NATUREL RECTIFIÉ . NATURBELASSEN REKTIFIZIERT . NATURAL RECTIFICADO
 GRIP RETTIFICATO . GRIP RECTIFIED . GRIP RECTIFIÉ . GRIP REKTIFIZIERT . GRIP RECTIFICADO

MOOV
 FORMATTI . SIZES . FORMATS . FORMATS . FORMATS . FORMATS

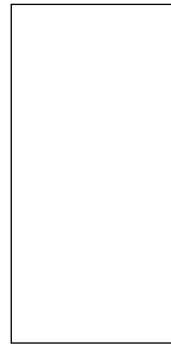
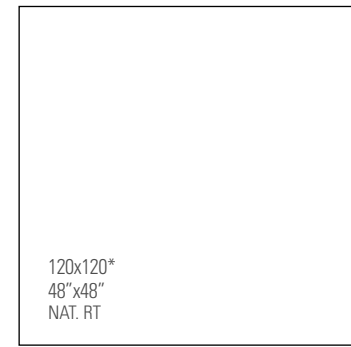
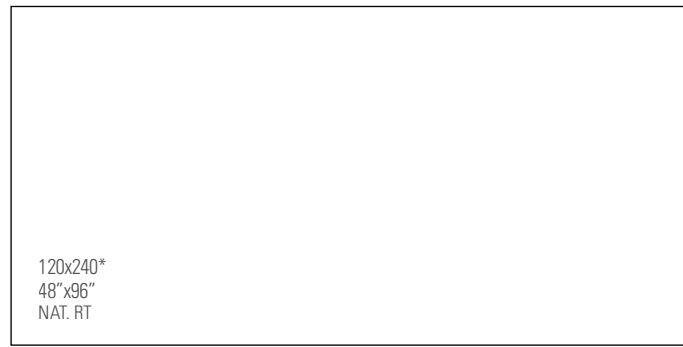

60x120
 24"x48"
 NAT. RT



30x120
 12"x48"
 NAT. RT

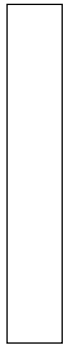

20x120
 8"x48"
 NAT. RT

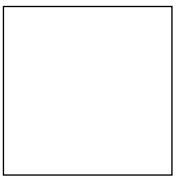

60x60
 24"x24"
 NAT. RT

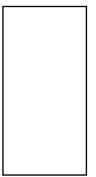

30x60
 12"x24"
 NAT. RT
 GRIP RT

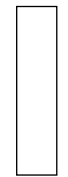

14,7x60
 5 3/4"x24"
 NAT. RT



9,7x60
 3 7/8"x24"
 NAT. RT

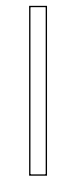

6,4x60
 2 1/2"x24"
 NAT. RT

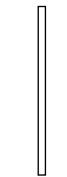

3,1x60
 1 1/4"x24"
 NAT. RT

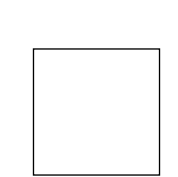

45x45
 18"x18"
 NAT.

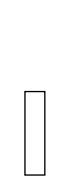

7,5x30
 12"x3"
 NAT.



*Misura Nominale - Nominal Size: 1195x2390 mm - 1195x1195 mm

MOOV
 FORMATTI . SIZES . FORMATS . FORMATE . FORMATS

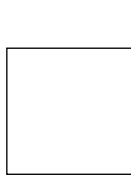
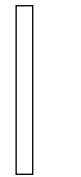
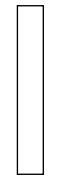
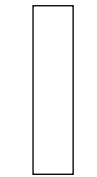
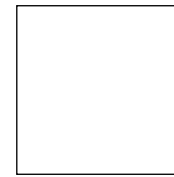
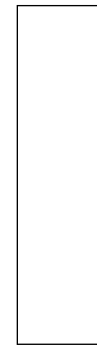
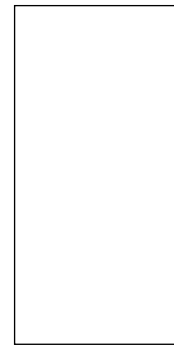
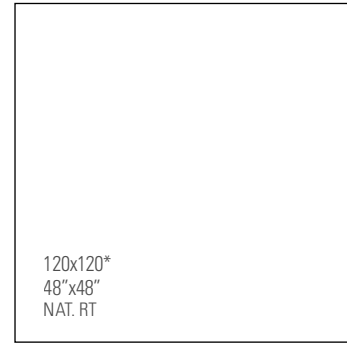
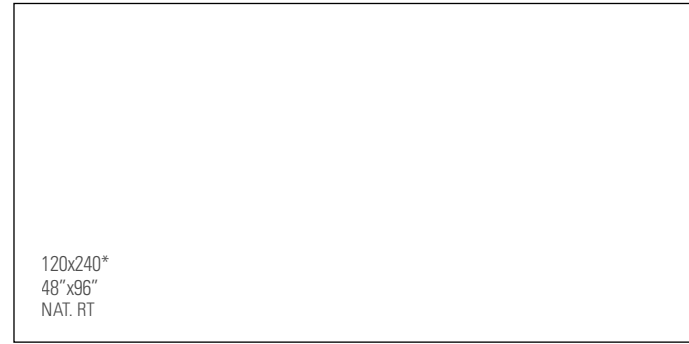

SCHEMI DI POSA

LAYING PATTERNS . SCHÉMAS DE POSE . VERLEGUNGSSCHEMEN . ESQUEMAS DE COLOCACIÓN

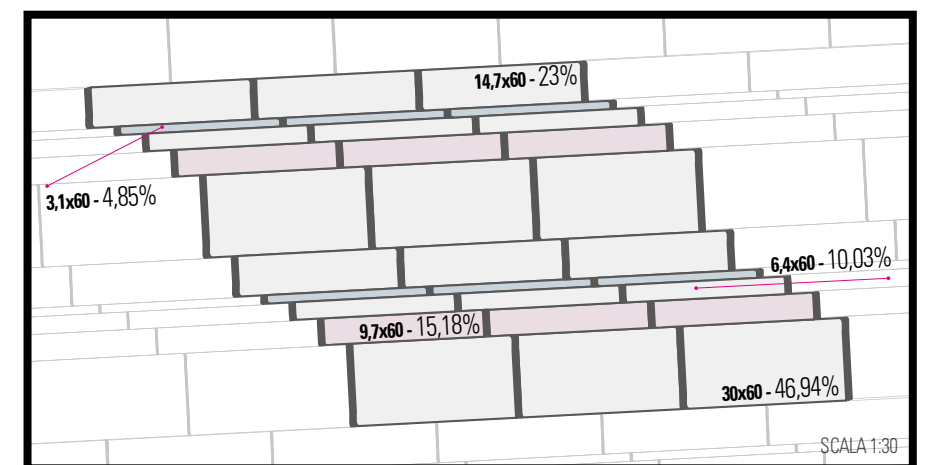
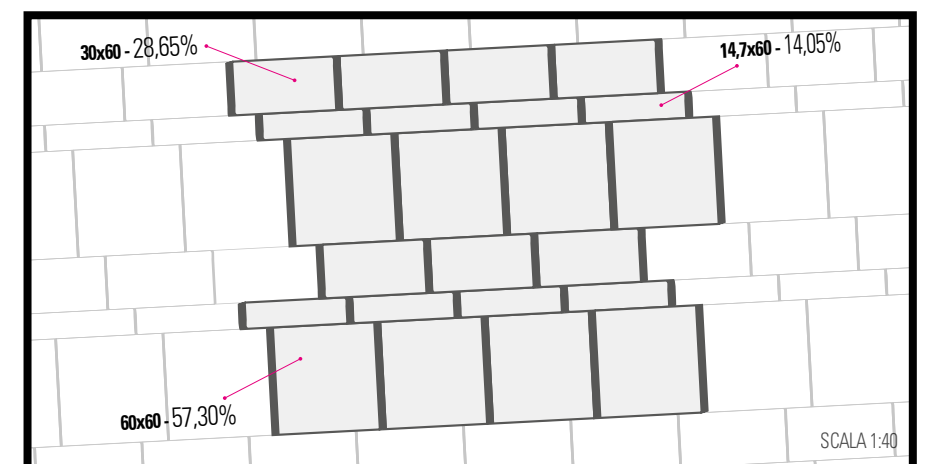
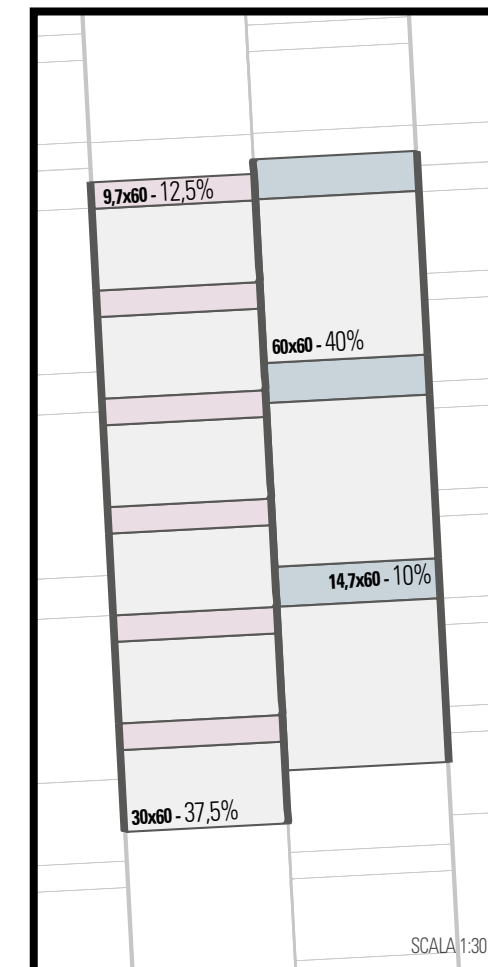
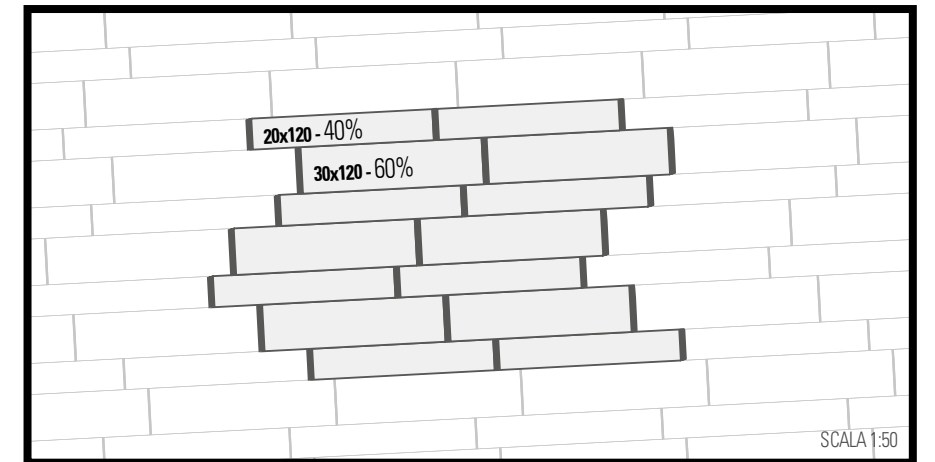
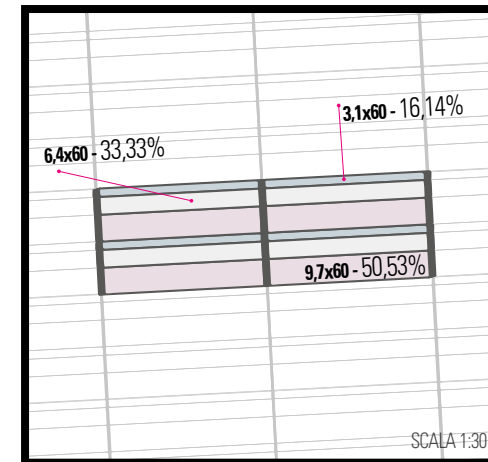
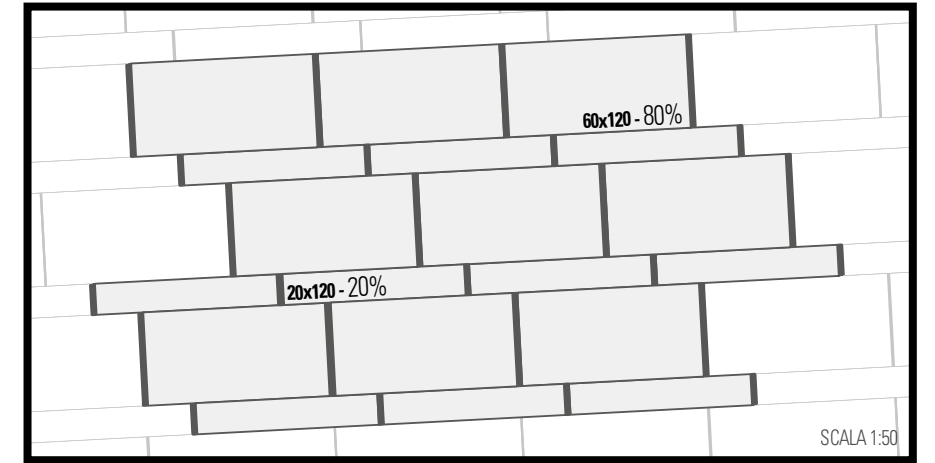
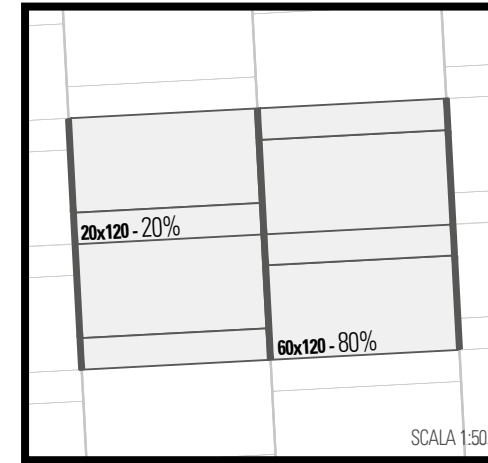

DECORI

DECORS . DECORATIONS . DEKORE . DECOROS



** STRIPS
30x60 - 12"x24"

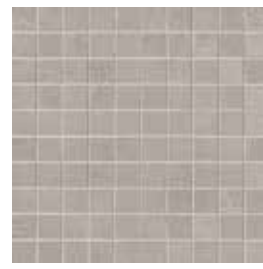

** MOSAICO
30x30 - 12"x12"
(TOZZETTO: 2,8x2,8 - 1 1/8"x 1 1/8")

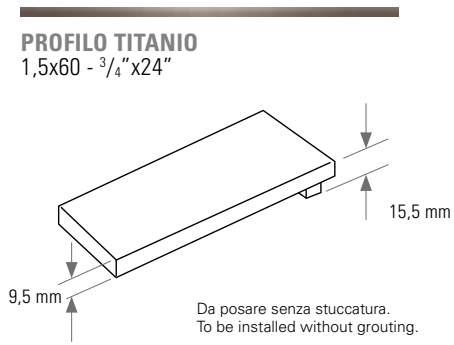

** LISTELLO UP
6,4x60 - 2 1/2"x24"



** LISTELLO UP
9,7x60 - 3 7/8"x24"

TUTTI I PROFILI DI VETRO E METALLO DI CERAMICHE KEOPE POSSONO ESSERE ABBINATI A QUESTA COLLEZIONE.
 ALL GLASS AND METAL PROFILES OF CERAMICHE KEOPE CAN BE COMBINED WITH THIS COLLECTION.

PEZZI SPECIALI

TRIMS . PIECES SPECIALES .
 FORMTEILE . PIEZAS ESPECIALES

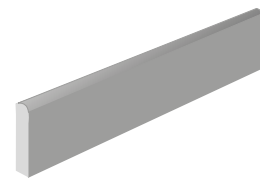

**BATTISCOPIA RT
7,2x60 - 2,8"x24"
BULLNOSE RT . PLINTHE RT
SOCKEL RT . RODAPIE RT

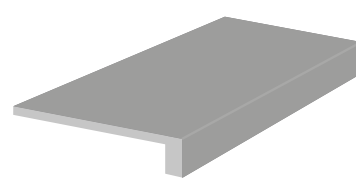

• SCALINO CON PROFILO INCOLLATO RT
33x60 - 13"x24"
GLUED STEP TREAD RT.
NEZ DE MARCHE COLLÉ RT.
GEKLEBTE STUFENPLATTE RT.
PELDANO CON PERFIL PEGADO RT.

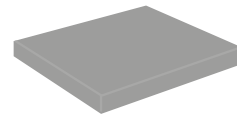

• SCALINO ANGOLARE CON PROFILO INCOLLATO RT
33x33 - 13"x13"
GLUED CORNER STEP TREAD RT.
CARREAU DE MARCHE COLLÉ PIÉCE ANGULAIRE RT.
GEKLEBTE STUFENPLATTE ECKSTÜCK RT.
PELDANO ESQUINA CON PERFIL PEGADO RT.

• Disponibile in tutti i colori, nella finitura strutturato e naturale, solo su ordinazione . • Available in all the colours in the textured and natural finish on order only . • Disponible dans tous les couleurs structuré et naturel uniquement à la demande . • Auf Anfrage, verfügbare in allen Farben der strukturierten und naturbelassen Ausführung . • Disponible en todos los colores en el acabado estructurado y natural sólo bajo petición.

** Disponibile in tutti i colori - ** Available in all the colours - ** Disponible dans tous les couleurs - ** In allen Farben in der Ausführung - ** Disponible en todos los colores

MISURE, PESI ED IMBALLI

SIZE, WEIGHT AND PACKAGING . FORMATS, POIDS ET EMBALLAGES . MASSE, GEWICHTE UND VERPACKUNGEN . MEDIDAS, PESOS Y EMBALAJES

| FORMATO size format formato | spessore | PZ/SCATOLA pieces/box pièces/bôte stück/karton pzac/caja | MQ/SCATOLA mq/box mq/bôte mq/karton mq/caja | KG/SCATOLA kg/box kg/bôte kg/karton kg/caja | MQ/PALLET mq/pallet mq/pallet mq/pallet mq/pallet | KG/PALLET kg/pallet kg/pallet kg/pallet kg/pallet | SCATOLA/PALLET box/pallet bôte/pallet karton/pallet caja/pallet |
|--------------------------------------|----------|--|---|---|---|---|---|
| | | 1 | 2,856 | ≈ 58,00 | 51,408 | ≈ 1064 | 18 |
| 120x240** | 9,00 mm | 1 | 2,856 | ≈ 58,00 | 51,408 | ≈ 1064 | 18 |
| 120x120** | 9,00 mm | 2 | 2,856 | ≈ 58,00 | 57,121 | ≈ 1180 | 20 |
| 60x120 | 10,0 mm | 2 | 1,44 | ≈ 33,40 | 21,60 | ≈ 521 | 15 |
| 30x120 | 10,0 mm | 4 | 1,44 | ≈ 33,50 | 23,04 | ≈ 612 | 16 |
| 20x120 | 10,0 mm | 6 | 1,44 | ≈ 33,50 | 21,60 | ≈ 1226 | 36 |
| (K2) 90x90 | 20,0 mm | 1 | 0,81 | ≈ 38,00 | 14,58 | ≈ 697 | 18 |
| 60x60 | 9,5 mm | 3 | 1,08 | ≈ 23,80 | 43,20 | ≈ 972 | 40 |
| (K2) 60x60 | 20,0 mm | 2 | 0,72 | ≈ 33,80 | 21,60 | ≈ 1034 | 30 |
| 30x60 | 9,5 mm | 6 | 1,08 | ≈ 23,80 | 43,20 | ≈ 972 | 40 |
| 14,7x60 | 9,5 mm | 12 | 1,058 | ≈ 22,00 | 31,75 | ≈ 680 | 30 |
| 3,1x60 | 9,5 mm | 30 | 0,558 | ≈ 13,00 | 33,48 | ≈ 800 | 60 |
| 6,4x60 | 9,5 mm | 15 | 0,576 | ≈ 12,48 | 41,47 | ≈ 770 | 60 |
| 9,7x60 | 9,5 mm | 10 | 0,582 | ≈ 13,00 | 34,92 | ≈ 800 | 60 |
| 45x45 | 9,0 mm | 5 | 1,0125 | ≈ 21,00 | 33,41 | ≈ 713 | 33 |
| 7,2x30 | 8,5 mm | 48 | 1,08 | ≈ 19,02 | 51,84 | ≈ 926 | 48 |
| 7,2x60 batt | - | 10 | ml 6,00 | ≈ 10,50 | - | - | - |

**Misura Nominale - Nominal Size: 1195x2390 mm - 1195x1195 mm

| FORMATI | 120x240** | 120x120** | 60x120 | 30x120 | 20x120 | 90x90 | 60x60 | 30x60 | 14,7x60 | 3,1x60 | 6,4x60 | 9,7x60 | 45x45 | 7,5x30 | 7,2x60 | 33x60 | 33x33 |
|----------|-----------|-----------|---------|---------|--------|---------|---------|---------|------------|------------|------------|------------|---------|--------|---------------|-----------------------------|------------------------------|
| sizes | 48"x96" | 48"x48" | 24"x48" | 12"x48" | 8"x48" | 36"x36" | 24"x24" | 12"x24" | 5 3/4"x24" | 1 1/4"x24" | 2 1/2"x24" | 3 7/8"x24" | 18"x18" | 3"x12" | 2,8"x24" | 13"x24" | 13"x13" |
| formats | | | | | | | | | | | | | | | battiscopa RT | *scalino prof. incollato RT | *angolare prof. incollato RT |
| formate | | | | | | | | | | | | | | | | | |
| formatos | | | | | | | | | | | | | | | | | |

| | | | | | | | | | | | | | | | | | |
|-----------------|---|---|---|---|---|---|----|----|---|---|---|---|---|---|---|----|----|
| Moov Ivory | ■ | ■ | ■ | ■ | ■ | | ■ | ■● | ■ | ■ | ■ | ■ | ○ | ○ | ■ | ■□ | ■□ |
| Moov Beige | ■ | ■ | ■ | ■ | ■ | | ■△ | ■● | ■ | ■ | ■ | ■ | ○ | | ■ | ■□ | ■□ |
| Moov Moka | ■ | ■ | ■ | ■ | ■ | △ | ■△ | ■● | ■ | ■ | ■ | ■ | ○ | ○ | ■ | ■□ | ■□ |
| Moov Grey | ■ | ■ | ■ | ■ | ■ | △ | ■△ | ■● | ■ | ■ | ■ | ■ | ○ | | ■ | ■□ | ■□ |
| Moov Anthracite | ■ | ■ | ■ | ■ | ■ | △ | ■△ | ■● | ■ | ■ | ■ | ■ | ○ | | ■ | ■□ | ■□ |

**Misura Nominale - Nominal Size: 1195x2390 mm - 1195x1195 mm

■ naturale rettificato - natural rectified - naturel rectifié - naturbelassen rektifiziert - natural rectificado

















□ strutturato rettificato - textured rectified - structuré rectifié - strukturiert rektifiziert - estructurado rectificado

○ naturale - natural - naturel - naturbelassen - natural

● grip rettificato - grip rectified - grip rectifié - grip rektifiziert - grip rectificado

△ strutturato rettificato, spessore 2cm (K2) - Textured rectified 2cm thickness (K2) - Structuré rectifié 2cm d'épaisseur (K2)
 Strukturiert rektifiziert Feinsteinzeug mit 2cm (K2) - Estructurado rectificado espesor 2cm (K2)

CARATTERISTICHE TECNICHE (SPESSORE - THICKNESS: 10 mm - 9,5 mm - 9 mm)
PIASTRELLE PRESSATE A SECCO - CONFORME ALLA NORMA EN 14411 E ISO 13006 APPENDICE G GRUPPO BIa CON E ≤ 0,5 % UGL
TECHNICAL FEATURES - DRY PRESSED TILES - COMPLIANT WITH STANDARDS EN 14411 AND ISO 13006 ANNEX G GROUP BIa WITH E ≤ 0,5 % UGL

| | CARATTERISTICA TECNICA TECHNICAL FEATURES | NORMA SPECIFICATION | VALORE PRESCRITTO VALUES REQUIRED N ≥ 15 cm | *VALORE KEOPE *KEOPE VALUES |
|---|--|--------------------------|---|---|
| CARATTERISTICHE DI REGOLARITA' REGULARITY CHARACTERISTICS |  LUNGHEZZA E LARGHEZZA LENGHT AND WIDTH | ISO 10545-2 | ± 0,6 % ± 2 mm | ± 0,2 % |
| |  SPESSORE THICKNESS | ISO 10545-2 | ± 5,0 % ± 0,5 mm | CONFORME IN ACCORDANCE |
| |  ORTOGONALITÀ RECTANGULARITY | ISO 10545-2 | ± 0,5 % ± 2 mm | ± 0,1 % CONFORME (45x45) |
| |  RETTILINEARITÀ DEGLI SPIGOLI STRAIGHTNESS OF SIDES | ISO 10545-2 | ± 0,5 % ± 1,5 mm | ± 0,1 % CONFORME (45x45) |
| |  PLANARITÀ SURFACE FLATNESS | ISO 10545-2 | ± 0,5 % ± 2 mm | ± 0,3 % |
| CARATTERISTICHE STRUTTURALI STRUCTURAL CHARACTERISTICS |  ASSORBIMENTO D'ACQUA WATER ABSORPTION | ISO 10545-3 ASTM C373 | ≤ 0,5 % | ≤ 0,1 % CONFORME IN ACCORDANCE |
| |  FORZA DI ROTTURA BREAKING STRENGHT MODULO DI ROTTURA MODULUS OF RUPTURE | ISO 10545-4 | ≥ 1300 N ≥ 35 N/mm² | CONFORME IN ACCORDANCE ≥ 40 N mm²* |
| CARATTERISTICHE SUPERFICIALI SURFACE CHARACTERISTICS |  RESISTENZA ALLA ABRASIONE PROFONDA RESISTANCE TO DEEP ABRASION | ISO 10545-6 | ≤ 175 mm² | ≤ 145 mm² |
| CARATTERISTICHE TERMO IGROMETRICHE THERMAL AND HYGROMETRIC CHARACTERISTICS |  COEFFICIENTE DI DILATAZIONE TERMICA LINEARE COEFFICIENT OF LINEAR THERMAL EXPANSION | ISO 10545-8 | METODO DI PROVA DISPONIBILE VALORE DICHIARATO TEST METHOD AVAILABE DECLARED VALUE | < 7x10 ⁻⁴ °C ⁻¹ |
| |  RESISTENZA AGLI SBALZI TERMICI THERMAL SHOCK RESISTANCE | ISO 10545-9 | METODO DI PROVA DISPONIBILE TEST METHOD AVAILABLE | GARANTITA GUARANTEED |
| |  RESISTENZA AL GELO FROST RESISTANCE | ISO 10545-12 | RICHIESTA REQUIRED | CONFORME IN ACCORDANCE |
| CARATTERISTICHE CHIMICHE CHEMICAL CHARACTERISTICS |  RESISTENZA AI PRODOTTI CHIMICI RESISTANCE TO CHEMICALS | ISO 10545-13 | METODO DI PROVA DISPONIBILE VALORE DICHIARATO TEST METHOD AVAILABE DECLARED VALUE | GARANTITA GUARANTEED |
| |  RESISTENZA ALLE MACCHIE RESISTANCE TO STAINING | ISO 10545-14 | METODO DI PROVA DISPONIBILE VALORE DICHIARATO TEST METHOD AVAILABE DECLARED VALUE | GARANTITA GUARANTEED |
| CARATTERISTICHE DI SICUREZZA SAFETY CHARACTERISTICS |  COEFFICIENTE DI ATTRITO DINAMICO DYNAMIC SLIDER | BCRA | METODO DI PROVA DISPONIBILE TEST METHOD AVAILABLE | > 0,4 |
| |  COEFFICIENTE DI ATTRITO STATICO STATIC SLIDER | ASTM C1028 | | R9 (naturale) R11 (strutturato - grip) |
| |  CLASSIFICAZIONE ANTISDRUCCIOLO INCLINED PLATFORM | DIN 51130 DIN 51097 | | A + B + C (grip) |

*VALORI MEDI RIFERITI A PROVE FATTE NEGLI ULTIMI 24 MESI, SUL FORMATO 60X60 - AVERAGE VALUES REFER TO TEST DONE IN THE PREVIOUS 24 MONTHS, ON SIZE 60X60

**MISURA NOMINALE - NOMINAL SIZE: 1195X2390 MM - 1195X1195 MM

"WS" MISURA DI FABBRICAZIONE - WORKING SIZE :
1194x2390 . 1194x1194 . 596x1195 . 297x1195 . 197x1195
596x596 . 297x596 . 147x596 . 97x596 . 64x596 . 31x596

VALORI "WS" RIFERITI AI CALIBRI DI PRODUZIONE: 120x240** (6), 120x120** (6), 60x120 (6), 30x120 (6), 20x120 (6), 60x60 (6), 30x60 (6), 14,7x60 (6), 9,7x60 (6), 6,4x60 (6), 3,1x60 (6)

VALUES "WS" RELATED TO THE PRODUCTION CALIPERS: 120x240** (6), 120x120** (6), 60x120 (6), 30x120 (6), 20x120 (6), 60x60 (6), 30x60 (6), 14,7x60 (6), 9,7x60 (6), 6,4x60 (6), 3,1x60 (6)



SPESSORE - THICKNESS:

90x90 - 60x60 (K2) : 20 mm
120x240 - 120x120** : 9,0 mm**
60x120 - 30x120 - 20x120 : 10 mm
60x60 - 30x60 - 14,7x60 : 9,5 mm
9,7x60 - 6,4x60 - 3,1x60 : 9,5 mm
45x45 : 9,0 mm
7,5x30 : 8,5 mm

**Misura Nominale - Nominal Size: 1195x2390 mm - 1195x1195 mm

Consigli di posa
Laying suggestions

Al fine di semplificare le operazioni di posa e ottimizzare la resa estetica del prodotto si raccomanda di posare con 2-3 mm di fuga.

To simplify laying operations and ensure the product looks its best, it is advisable to lay with joints of 2 to 3 mm.

Si suggerisce di posare i formati rettangolari affiancati o sfalsati di 2/3

It is recommended that you lay the rectangular formats side by side or offset by 2/3

La leggera stonalizzazione cromatica della superficie evidenzia la naturalezza del prodotto, per ottenere il migliore effetto estetico si raccomanda di posare attingendo contemporaneamente da scatole diverse.

The slight variations in surface colour shade highlight the naturalness of the product. To achieve the best visual results, it is advisable to mix tiles from different boxes when laying.

Subito dopo la stagionatura delle fughe si raccomanda di effettuare la pulizia del pavimento come descritto su:

www.keope.com/cleaning.html
 As soon as the joints have fully set, it is advisable to clean the floor as described on the website
www.keope.com/cleaning.htm

Per caratteristiche tecniche relative allo spessore 2 cm (nei formati 90x90 - 60x60) consultare il catalogo K2 (2cm) o www.keope.com
 For information about technical features of 2 cm thick items (Sizes 90x90 - 60x60), see the K2 (2 cm) catalog or **www.keope.com**



UNI ISO 14064

"GREENTHINKING" è il Progetto Keope nato per rispettare gli obiettivi di sviluppo sostenibile. Keope è una delle aziende oggi più attente alle qualità ecologiche dell'industria ceramica.

Al passo con la più avanzata evoluzione tecnologica, Keope si è impegnata a seguire un severo programma di tutela della eco-sostenibilità iniziato anni fa con l'adesione al Marchio Ecolabel, per arrivare oggi all'importante certificazione ISO 14064. Il marchio "Greenthinking" è il simbolo di questo impegno di Keope nei confronti della natura.

"GREENTHINKING" is the project that Keope has realised to fulfil the requirements of sustainable development. Keope is actually one of the companies with the higher attention level to the ecological characteristics in the tile industry.

In line with the most advanced technological evolution, Keope has committed itself to a strict programme of eco-sustainability, which began years ago by obtaining the Ecolabel and has continued with the attainment of the important ISO 14064 certification. The "Greenthinking" mark is the symbol of Keope's commitment to protection of nature.

www.greenthinking.it

MK progetto grafico omniadvert
 coordinamento ufficio marketing ceramiche keope
 fotoelaborazioni modofotografia.it
 stampa grafiche pioppi

Progetto, direzione e coordinamento a cura dell'Ufficio Marketing
 Editore: Ceramiche Atlas Concorde divisione Keope,
 Strada Statale 467, n°21 - 42013 Casalgrande (RE) Italia
 Pubblicazione: Dicembre 2016
 Finito di stampare a Reggio Emilia nel mese di Dicembre 2016 da Grafiche Pioppi,
 Via Venere di Chiozza, 10/1 - 42019 Scandiano (RE) Italia
 ©Copyright 2016 by Ceramiche Atlas Concorde divisione Keope

Project, editing and supervision by Marketing Department.
 Editor: Ceramiche Atlas Concorde divisione Keope,
 Strada Statale 467, n°21 - 42013 Casalgrande (RE) Italy
 Publication: December 2016
 Printed in Reggio Emilia in the month of December 2016 by Grafiche Pioppi,
 Via Venere di Chiozza, 10/1 - 42019 Scandiano (RE) Italy
 ©Copyright 2016 by Ceramiche Atlas Concorde divisione Keope



COMPANY WITH QUALITY MANAGEMENT
 SYSTEM CERTIFIED BY DIN
 = ISO 9001:2008 =



Ceramiche Keope
 S. S. 467 n 21 - 42013 Casalgrande (RE)
 EN 14411



Office strada Statale 467,21
42013 Casalgrande (RE) Italy
Phone +39 0522 997511
Fax +39 0522 997544 997545
Factory Via Dell'Industria 1,
Villaggio La Macina
42013 Casalgrande (RE) Italy
info@keope.com
www.keope.com



Ceramics of Italy